

NEC GROUP

COMPANY PROFILE



NEC GROUP
ALWAYS THERE FOR YOU

www.necgroupbd.com

WELCOME

A good businessman always keeps his eyes on the bigger picture while perfecting every minute detail. There is also a necessity for taking creative risks and grab every opportunity one can.

We continue to work hard and perfect all the nitty gritty details of a project to reach our maximum potential and keep our clients happy. We believe in creating value together and focusing on productivity.



Saddique Ali

CEO
NEC Group

CONTENT

Our Company	03
Newtech Technology	05
Newtech Branches	13
NITC (Newtech IT Training Center)	14
Task technology Ltd	15
Newport Express Corporation	20
Newport Express Courier	24
Holidays	27
Back To School Foundation	29

NEC Group was founded in 2004 as a private freight forwarding company with three basic operating promises:

Provide professional motivated customer service.

Expand without sacrificing either service to our customer or an To realize a sustained and controlled growth based on our ability to adequate return from our efforts.

To hire only professional personnel who are dedicated to the success of our company.

Mission

Our goal at NEC Group is to provide our clients with the most reliable, affordable, safe, and convenient services possible. Assuring the most excellent standards of security and dependability, we are committed to streamlining and improving the user experience. Every facet of our service is anchored by our affordability and unshakable reliability, which reflects our core values and unwavering commitment to excellence. We aim to continuously surpass customer expectations and create a better future by using this mission to inform our strategies, operations, and innovations.

Vision

NEC Group is dedicated to providing outstanding service in various industries while creating creative answers to our client's problems. Adaptability, dependability, and consistency are the cornerstones of our business philosophy and are essential to our methodology. This unwavering dedication guarantees that we not only fulfill but surpass the expectations of the people we assist, solidifying our position as a reliable and prominent organization in our sector



With a large network of affiliates, we work to satisfy any needs our clients may have and find strategic alliances to fill in any gaps.



Newtech Technology



NITC
(Newtech IT Training Center)



Task Technology Ltd



Newport Express Corporation



Newport Express Courier



Newport Holidays



Back To School Foundation

We are enlisted to following International & local organizations

- BAFFA (Bangladesh Freight Forwarding Association)
- JANCO (Global Logistics Limited)
- IAEAB (International Air Express Association of Bangladesh)
- CAAB (Civil Aviation Authority of Bangladesh)
- ACAAB (Air Cargo Agent Association of Bangladesh)
- BCS (Bangladesh Computer Samity)
- BCA (Bangladesh Civil Association)

We have the following licenses in our organization

- Freight Forwarding and Shipping by Bangladesh Government
- International Courier by Bangladesh Government
- Custom Brokerage by Bangladesh Government



Newtech Technology

BCS SL No : 0048
BCS Membership : 1673



Task Technology Ltd

BCS SL No : 0008
BCS Membership : 2609



Task Technology Ltd

eCab Membership No : 1891



Newport Express Corporation

JCTRANS Membership No : 111229



Newport Express Corporation

BAFFA Membership No : 1226



Newport Express Courier

IAEAB Membership No : 20



Newport Holidays

IATA Code No : 42343685

Introduction

Newtech provides a comprehensive repair, logistics, and spare part support solution, sourcing from our overseas offices and local markets.

With its state-of-the-art lab, Newtech can repair any IT equipment. We provide non-warranty support for all currently available local markets and warranty support for some of the most respected brands.

Newtech offers certified engineers to meet operational requirements for a variable period. Our Engineers are available 24/7, with on call support for networking & on site devices



The team is made up of engineers with experience in commercial and consumer printers as well as scanners. These include photo copiers, laptops, IP phones, servers, modems, power supplies, UPS units, and ATMs. Routers, Graphic cards, Hard drives, RAM, Motherboards, and Gaming Devices.

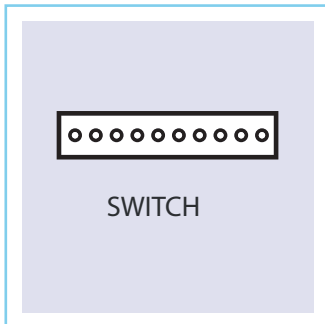
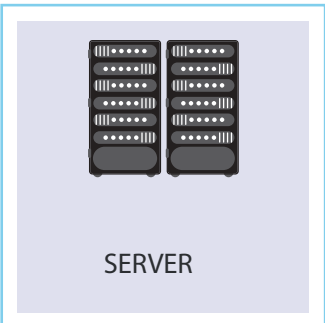
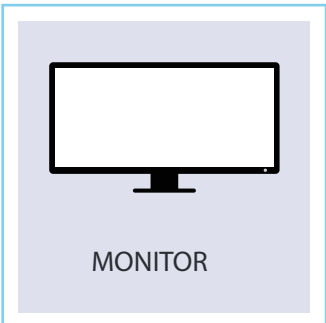
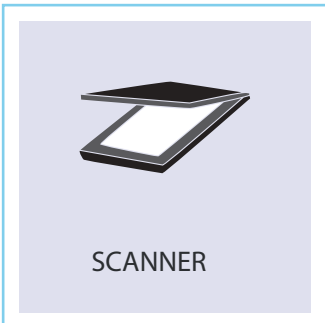
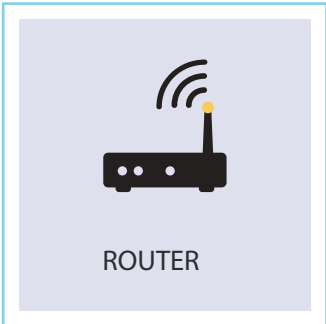
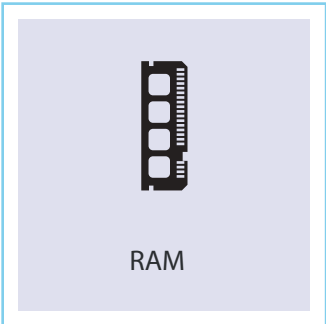
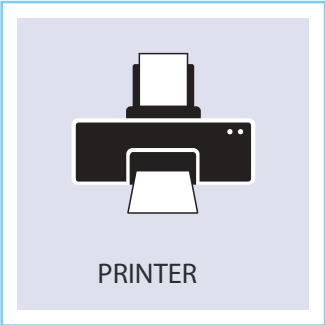
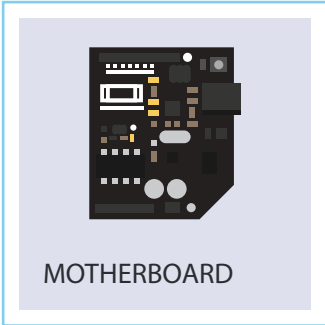

Newtech has a state-of-the-art lab fully equipped to repair various types of IT equipment.

Our company uses the newest security and safety technologies to safeguard your products. We have also taken all necessary fire safety precautions and installed security cameras throughout the building to provide the utmost protection for all of your products.



Research & Development

Our engineers fix the product in addition to examining the cause of the problem and devising solutions to prevent it from happening again and delaying important work.

At Newtech, we're always looking for ways to prevent troubleshooting from happening again because it damages the device and takes up valuable work time.





Importing warranty replacement parts, exporting defective components, warehousing, recycling e-waste, conducting CID checks, local delivery, and IPG printer repair



Importing warranty replacement parts, exporting defective parts, storing and scraping e-waste, local delivery, and L1, L2, L3, and L4 notebooks, desktop, and monitor repair are all included.



**Hewlett Packard
Enterprise**

Importing replacement parts under warranty, exporting defective parts, storing and recycling e-waste, and providing local delivery around the clock.



Importing warranty replacement parts, exporting defective parts, storing and scraping e-waste, local delivery, and L1, L2, L3, and L4 notebooks, desktop, and monitor repair are all included.



Import of spare parts and complete repair assistance for switches and routers

Motherboard And VGA card Repair

With specialized modern Experts and professional, well trained, engineers. Newtech is one of the best repair centers in the country with a 97% repair rate success.



Notebook Repair

With both level 2 and level 3 engineering teams we can diagnose and repair all Notebook Problems, with yearly training to keep all technicians up to-date about all new technology and 24-hour support.



Router, Switch And Server Motherboard

With network engineers to calibrate most router issues to simple troubleshoot. ic replacement and network repair.





Lvps change & Repair
Fuser change & Repair
Printhead change

Lsu change & Repair
Motherboard change & Repair
Mechanical change & Repair

Carriage change & Repair
Scanner change & Repair

Panel & Motherboard



Our skilled technicians handle all of our monitors and LCD panel repairs. Specialized tools, like COF and polarizer machines, come with a supply of original polarizer paper and yearly training to stay current with emerging technologies and market competition.



After the equipment, part, or device is successfully fixed, it is given to the quality control team for a final inspection. At that point, a summary report is produced with all the pertinent information, including the name of the engineers, the part they fixed or replaced, and the engineer's identity who performed the quality inspection. We give you a 90-day warranty period on all your repaired products and provide a clear explanation on the website if a repair is impossible.

Customer Survey



Our responsibility is to ensure that all of your needs are satisfied and that you receive the best possible service and aftercare.

We welcome feedback from all of our clients so that we can improve both our products and services. Please fill out our survey if you have any complaints or issues.

Technologies



OpenMRS
OpenSRP

Artificial Intelligence
Machine Learning

IoT (Internet of Things)
Business Intelligence (Tableau)

Banani Branch



Tejgaon Office :
(Central Service Center)
Bhuiya Sikder Tower
304 Tejgaon I/A(2nd floor- Lift 2),
Dhaka- 1215
Phone: +88-02-41082640

Multiplan Branch

Multiplan Office :
Suite-1406 & 1419, Level-14, Multiplan Center
69-71 New Elephant Road, Dhaka-1205
E-mail : service@newtechbd.net



Chittagong Branch

Chattagram Office :
M. Court (Old), Bashar Square (5/FL)
108 Agrabad C/A, Chattagram-4100
Tel : +88 031-2513286, 2513287

Sylhet Branch

Sylhet Office :
510, Level-4 (5th Floor),
West World Shopping City
Jallarpar, Zindabazar, Sylhet-3100
E-mail : service@newtechbd.net

NITC is an innovative Technical Training Institution. From a hands-on Education to Opportunities to work alongside top industry professionals. There is countless reason to students choose NITC.



Course Criteria

Course & Certification

Software Training

Hardware maintenance.

Hardware Programming.

Circuit Level: L-3, L-4.

Placement Assistant.



Software Development

NewTech is an IT and Internet of Things company that provides consulting services in software development, IT infrastructure management, security infrastructure design, quality assurance, and implementation. Highly experienced IT professionals run it. NewTech has excellent experience providing solutions in environments with one or more operating systems.



Software Development Services

This is the center of innovation. Welcome. Our expertise lies in developing state-of-the-art software solutions that propel your business ahead at Task Technology. To create software that explicitly satisfies the needs of users or organizations, programmers and software developers engage in various tasks and activities known as software development. Furthermore, our software solutions fulfill the most stringent requirements for functionality and achievement. The goal of our knowledgeable staff is to use code to realize your vision. Let's, therefore, make your ideas a reality and grow your company to new heights.



Website Development



It's your storefront, the Internet. Our specialty at Task Technology is aesthetically pleasing and incredibly functional website design. The process of building and managing websites for the Internet is commonly referred to as "web development." Furthermore, the team responsible for developing our website possesses technical proficiency and creative sensibilities. We provide UX/UI, responsive website design, maintenance, and e-commerce solutions. Priority is given to the needs of the projects that we represent. You end up with a solution that improves user engagement and yields tangible outcomes.



Would You Want to See a Varying Monthly or Annual Return on Investment (ROI)? Being successful in the digital age requires having a solid online presence. In the constantly changing digital marketing landscape, Task Technology is your reliable guide. We have designed our entire service portfolio to increase audience engagement and produce meaningful outcomes. Search engine optimization (SEO), website SEO audits, content marketing, technical SEO, Google Ads (PPC) services, social media marketing, e-commerce SEO, local SEO, link building, and other services are among the most in-demand services provided by Task Technology. Let's embark on a digital marketing adventure that will turn the internet presence of your business into a helpful tool. For further information, kindly reach out to us.

Our Customers

Repair, Logistics Customer

HP | MSI | D-Link | Acer | CP-Plus

Software User/ Customer

NapRide (A vehicle Rental System)

Delivery Management Automation Solution for Chitra Express

Full Customized Automation ERP Solution for Newtech Technology

Blood Group Finding Automation Solution with Android and Web App

Travel Agency Automation System for SoftCore IT Ltd.

Behula Bangla Publications Automation Solution

Hospital Management Automation System for Bheramara Popular Diagnostic Center



Task Technology offers an IOR/EOR solution that makes it easy for clients to expand into Bangladesh. You must have a fiscal presence in the counting process to import or export goods in Bangladesh. Task technology can help businesses that need a successful corporate company by using an entity for tasks.

Task Technology Will:

- Act as The Importer/Exporter for customs and taxation purposes at The time of Import/Export
- Be responsible to customs tax and other regulations authorities
- Apply for necessary import/Export licenses and Permits
- Apply MOL Permission and IP/EP CCIC approval

Solutions

- Assist in completion of all paper works to support The Shipments.
- Act as an IOR in order to facilitate The Import of the goods into the Country
- Act as Eor for Export of defective Items if rejected or assist in scrapping
- Act as logistics for Both Express and regular shipments
- Packing of the goods providing our own Boxes and material for safe packing.

Scrapping

Our Mission

Our logistics team has years of experience. We obtain scrap products from our esteemed client in Bangladesh and dispatch them to our mission to establish an industry for metal recycling through "Azizu Recycling & E-Waste- Company." Narayanganj Road in Dhaka. Shiddhirganjin Bangladesh initiated an initiative to develop its capital up to this point.

Azizu provides a comprehensive support chain with NEC for scrap collection, transportation, storage, and recycling. "TO PROMOTE A GREEN BANGLADESH AS WELL AS A GREEN WORLD" is the only motto. Ewaste management and recycling were the only goals of Azzu Recycling and F-Waste Company Ltd.Ltd. when they were founded in 2013.



Production process/west PCB Recycling Plant.



An incredible amount of e-waste is produced by the world's continued rapid replacement and consumption of electronic devices. Electronic component recycling helps businesses cut their carbon footprint and prevent millions of tons of hazardous waste from ending in landfills worldwide. Prominent electronic manufacturers such as Dell Technologies, Intel, HP & HPE, MSI, and ACER are leading creative initiatives to tackle this worldwide issue and set a model for other businesses. This article reviews some suggestions for electronic recycling that your company should consider for your CSR campaigns.

Azizu Recycling and E-Waste Company is a fully functional facility for recycling electronic waste (Ewaste). The factory is in an industrial area close to Dhaka on a large plot of land with good communication facilities. The factory's promoters are well-educated, well-respected individuals with solid business backgrounds. The promoters' close ties to "TES-AMM," a Singapore company, have given them over 15 years of experience in recycling electronic waste.





About

Licensed in Bangladesh and a member of the Bangladesh Freight Forwarders Association, Newport Express Corporation is a freight forwarding business offering comprehensive logistical services catering to buyers, shippers, and manufacturers of all shapes and sizes for international air and ocean transportation. In addition to providing air freight, ocean freight, SEA/AIR freight (via DXB), ocean consolidation, warehousing and distribution, supply chain management, customs brokerage, inland transportation, door-to-door services, value-added services, etc., we also have offices in Dhaka and Chattagram, Mongla.



Air Freight Ocean Freight Warehousing
Distribution Supply Chain Customs brokerage Door to Door

What We Do

We offer dependable international shipping services that add value and help our clients succeed internationally. To enable trade while continuously addressing logistics and transportation needs Around the world, creative and economical multimodal services

To offer top-notch air ocean freight forwarding, shipping, and consolidation services that are fully integrated, comprehensive, and satisfy each customer's specific needs and demands prepared to share resources and information continuously to offer a chain of services

The support we provide are categorized below



AIR FREIGHT

- Low negotiated rates
- Locally managed space allocation
- Closely managed cargo handling
- Container building
- Aircraft chartering
- Online tracking links
- Online booking
- Perishable and dangerous goods expertise

OCEAN FREIGHT

- Low negotiated rates
- Full container load (FCL)
- Less than container load (LCL)
- Inland tracking
- Door to door service
- Project Cargo
- Online booking
- Online tracking

CFS FACILITIES & VAS

- 24 hours security
- Flood free zone
- Customs inside the off dock
- 24 hours cargo receiving/ stuffing facility
- Late gate stuffing/loading

CUSTOMS BROKERAGE

- Compliance consulting
- Export documentation
- Duty drawback and assessment and filing
- Entry processing export
- Online duty and tax calculation

INTERNATIONAL COURIER

- Door to door delivery
- Local Pick-ups
- Packaging
- Bonded warehouse
- Regional deliveries
- Incoming courier

Service

We are a leading supplier of cutting-edge air cargo options. Our portfolio of airlines has been carefully selected based on factors such as flight frequency, capacity, and service reliability.

Our expertise allows us to provide project forwarding and logistics management services to many clients worldwide.

We provide flexibility by providing weekly railings and various departure options tailored to meet supply cycle demands.



Newtech directly imports the parts needed to repair the equipment through our offices in China, Singapore, and Hong Kong, guaranteeing that the repairs are made at the most competitive prices. Your IOR is Newtech. To import your products or parts without incurring penalties, we prepare all the paperwork Bangladeshi customs require for your import (IOR). To import your networking devices spectrum and non-spectrum—with permission from the Bangladesh Telephone Regulatory Commission, Newtech also possesses its own BTRC license.

Project Cargo





- World Class products and services to offer.
- A fleet of specialized equipment for providing logistical support.
- Over 38 specialized and general operators and technicians of high performance levels.
- Professional and confident enough to take up even new challenging jobs.
- Striving for best quality products & service.
- Involved in some capacity or others in all world class projects in Bangladesh.
- We have built up a reputation of completing jobs ahead of schedules.

Customs Brokerage



If your company imports or exports goods, you must partner with a shipping services provider that can expedite the clearance of your goods through customs. NEC is a group of highly skilled customs brokers knowledgeable about tariffs and customs laws. This knowledge enables them to anticipate and steer clear of potential roadblocks to customs clearance.



When Newport Express Courier (NEC) was founded, it aimed to offer motivated, professional customer service in international courier services and warehousing management systems. Our team's strength is our ability to handle supply chain management, 3PL projects, and cargo; each member has years of experience in their respective fields.

About



Our professional operations team, with extensive experience managing cargo with ports, customs, and transport agencies, has helped us establish a formidable reputation in project cargo logistics and heavy lift shipments. Technical engineering services and creative Project Cargo Handling solutions are what we provide.

We manage facilities designed explicitly for the 3PL IT industry. In warehousing, goods are kept in a multipurpose space with goods from other clients. They are subject to the highest security standards, cycle counting, physical inventory verification, product inspection, and insurance coverage. NEC provides its clients, serving as their IOR/EOR, with an exclusive solution. NEC prepares all the paperwork required for your imports at Bangladeshi customs. To ensure that the defective parts arrive on time, NEC obtains special permission from the relevant authority before returning defective parts.

FOR OUR VALUABLE CUSTOMERS

NEC imports warranty spare parts and uses our partner network of courier services to operate parcel and freight express courier services across the globe from our hub in Singapore. Lithium batteries are regularly shipped over the ocean. Airlines Express Service handles parts air shipments (to Dhaka) from all over the world.

NEC provides 3PL warehousing services in facilities specifically designed for the IT industry. Products are stored in these facilities alongside those of other clients, all under the highest security and insurance coverage standards, using software designed for IT industry inventory and tracking.

The distribution team at NEC always ensures that the goods cleared from the airport or in stock in our warehouse get to our clients on schedule so they can serve their end users. Ground transport is in constant motion, delivering the goods that customers have ordered door to door.

Before shipping parts to Singapore, NEC also manages the screening process for customer-induced damages (CID). NEC-trained personnel inspect all exported parts for significant damage to components like motherboards, LCD panels, hard drives, etc.



Scraping at our cutting-edge facility in Dhaka, NEC recycles your E-Waste in the most effective and ecologically responsible way possible. By handling the logistics, we protect businesses from the financial, legal, and environmental risks of disposing of their electronic waste and make the process simple and hassle-free.

Defective Export: We thoroughly inspect returned faulty parts and notify the manufacturers if they need to be returned to their facilities. We process these parts once a week and send the defective parts to the manufacturers when they ask.



NEC manages the monitoring and repair of the Monitor AMR Project under warranty. The partners bring the fixed monitors into the NEC warehouse, where they are stored as BB (refurbished) monitors. The partners receive the same model of monitor they have requested, and the monitors are distributed to them according to their needs.

IPG consumer printer support: NEC offers post-purchase assistance for IPG consumer printers in Bangladesh. The aid includes refurbishment and repair services, which are dependent on appointment partners in Bangladesh.



We are powered by the Bangladeshi Civil Aviation Authority's license. With various embassies, this unit collaborates closely. NGOs and international businesses. We are a team of organized salespeople who constantly contact airlines and travelers to provide updates on new travel packages and book hotels for clients around the globe.



Service



International and domestic air tickets



Holiday package tour in Bangladesh and Worldwide



Hotel booking worldwide

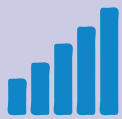

Constant connection with customers with updates and better rates



Ticket reconfirmation and reservation



24/7 customer support



Travel in Style



1. SELECT YOUR DESTINATION

Select a destination where you want to see yourself.

2. BOOK A HOTEL

Browse through the hotels and chose your view.

3. VISA

We are there for your Visa processing for Egypt, India, Thailand, Indonesia, Malaysia, Singapore, Nepal, Mauritius, Myanmar and China

4. PACK YOUR BAG

While we do the work, get ready and start your packing and get ready for the vacation



Your Dream & Our Passion

Back To School Foundation Corporate Social Responsibilities



To a Bangladesh that is free, strong, and educated. Our goal at the Back to Education Developmental Organization (BEDO) is to return opportunities that have been taken advantage of.

By supporting schools throughout Bangladesh and giving them the necessary financial and educational resources, BEDO hopes to provide every child with the opportunity to receive an education. Additionally, we want to provide exceptionally talented students with scholarships on a national and international level.

BEDO offers technical training and equips students with the know-how to install, maintain, and repair various systems and components.

BEDO believes that education is a fundamental human right and that a society devoid of this value cannot progress. Join us in our mission to create a robust, accessible, and educated Bangladesh as committed people like you support us.







Energy Solution Tech is dedicated to transforming energy access for both residential and commercial sectors through innovative solar solutions. Guided by our core belief, "We believe in solutions," our mission is to combat the ongoing load-shedding challenges by offering reliable, solar-powered electricity for homes, businesses, and industrial zones alike. We recognize that consistent power isn't just a convenience; it's essential for productivity, comfort, and economic growth.



For industrial clients, we provide robust solar systems that are tailored to withstand high energy demands, reducing reliance on the traditional grid, minimizing downtime, and supporting sustainable growth. These solutions ensure that factories, warehouses, and other commercial facilities can operate seamlessly, boost productivity, and lower operational costs, all while minimizing environmental impact.





Energy Solution Tech

At Energy Solution Tech, we're more than an energy provider; we're partners in building a sustainable future. By providing clean, dependable power for homes, businesses, and industries, we empower our clients to achieve energy independence and take control of their energy future. With our solar solutions, we're driving progress, reducing environmental impact, and lighting the way toward a cleaner, more resilient energy landscape for all.



Energy Solution Tech

For residential users, we offer solar systems designed to provide a consistent power supply that enhances home comfort and energy independence. With rising electricity costs and power interruptions, our solar solutions allow homeowners to enjoy reliable energy while contributing to a greener future. Our residential solar installations are efficient, cost-effective, and adaptable, making clean energy accessible to households across the country.





Our team of energy specialists and engineers works closely with each client—whether home, business, or industrial—to design, install, and maintain solar systems that are tailored to their specific energy needs. We provide end-to-end services, from system design and installation to ongoing maintenance and support, ensuring long-term performance and reliability. Each solution is engineered with resilience, scalability, and efficiency in mind to maximize energy output and deliver consistent results.

Our Company AT A GLANCE





NEC GROUP
ALWAYS THERE FOR YOU

Head Office :

House-77, Road-7, Block-H, Banani, Dhaka-1213.
Tel : +88 02 41082641, 41082642

Tejgaon Office :

Bhuiya Sikder Tower
304 Tejgaon I/A(2nd floor- Lift 2), Dhaka-1215
Tel : +88 02 41082640

Multiplan Office :

Suite-1406 & 1419, Level-14, Multiplan Center
69-71 New Elephant Road, Dhaka-1205
E-mail : service@newtechbd.net

Sylhet Office :

510, Level-4 (5th Floor), West World Shopping City
Jallarpar, Zindabazar, Sylhet-3100
E-mail : service@newtechbd.net

Chattagram Office :

M. Court (Old), Bashar Square (5/FL)
108 Agrabad C/A, Chattagram-4100
Tel : +88 031-2513286, 2513287

Contact Us

E : info@necgroupbd.com

www.necgroupbd.com